

# RISE 4290HD Series with Command Core™

## H.264 Dual Spectrum Night-Vision Positioning System



### Lifetime Warranty Camera Head Moisture Ingress



### Command Core™ Action Engine

- Automated camera responses
- Preset/Tour activations
- Digital I/O triggers and actions
- Image snapshots with FTP/EMAIL delivery
- Built-in Configuration Wizards
- Three trigger queuing modes

CohuHD Costar's 4290HD dual spectrum positioning system is the latest addition to CohuHD's RISE family of products, combining crystal clear HD visible spectrum imaging along with standard resolution LWIR night vision imaging for delivering unmatched performance at an affordable price.

The 4290HD visible spectrum camera provides full 1080p imaging with 30x optical zoom, delivering full frame rate HD images over the entire zoom range for very cost effective long-range surveillance applications.

The visible camera provides defog/dehaze image processing, enhancing video performance in foggy and hazy conditions encountered in surveillance and traffic monitoring applications.

The 4290HD night vision camera offers uncooled VOx 640x480 LWIR FPA detectors with continuous 6x zoom, dual FoV or fixed focal length hard carbon coated lenses.

The 4290HD thermal imaging delivers high quality video, even in extreme conditions such as total darkness, smoke, atmospheric haze or

### Superior Visible Imaging and Optics

- Superior 1080p image quality
- Powerful 30x optical zoom with 12x digital zoom (360x total)
- Image defog/dehaze analytics
- Electronic image stabilization (EIS)
- Dark scene enhanced intensity
- Bright source whiteout reduction

### Rugged Construction

- Operates in hurricane force winds
- Built-in electrical transient/surge protection to CISPR 24 levels
- Precision positioning of 0.05°
- Factory purged and pressurized IP68 protection
- NEMA TS2 temperature range, -40°C to 75°C
- Integrated faceplate wiper option
- Inverted mounting capability
- 3 Year Standard Warranty, Lifetime Warranty on moisture ingress into camera head enclosures.

dust, rain, light foliage, and most types of fog.

The 4290HD includes variable hi-speed pan and tilt drive, with 360° continuous pan and 360° tilt. The high-torque motor and gearing design ensures the positioner maintains position in high shock, vibration and hurricane force winds.

Providing multiple video stream profiles, the 4290HD delivers up to 5 or more independently configured H.264/MJPEG streams as well as analog video output with serial RS422 camera PTZ control.

Simultaneous streaming of both visible and thermal camera images provides operator viewing and assessment of both spectrums for detection and identification of camera scene information.

The 4290HD provides a full function web server, allowing complete administrative and operator control capabilities. Administrative features include configuring network settings, user password assignments, setting video streaming properties, configuring camera imaging properties, defining presets and tours

### Advanced Night Vision Performance

- Night vision LWIR 8-14um spectrum
- VOx uncooled micro bolometer technology
- 640 x 480 resolution, 17um FPA
- Up to 6x Continuous zoom, dual FoV or fixed thermal optics options
- Auto-focus On-Demand (zoom/dual FoV options only)
- Synchronized optical zoom views

### Installation and Interoperability

- ONVIF Profile S, NTCIP 1205
- Hybrid IP/analog video-serial PTZ operation
- H.264 Base/Main/High profiles and MJPEG encoding
- Web server configuration, operation and viewing
- Single CAT5e/CAT6 cable with PoE++
- Pendant, wall, pole mounting options
- Built-In Setup Configuration wizards

and assigning camera ID labels.

The 4290HD is designed to operate in harsh weather with its purged and pressurized IP68 enclosure protection. This eliminates the effects of water intrusion, pollutants and corrosives.

CohuHD delivers years of clean, reliable images and backs it with a world class three-year warranty.



youtube.com/CohuHD  
linkedin.com/company/CohuHD  
twitter.com/CohuHD  
facebook.com/CohuHD  
CohuHD.com

# RISE 4290HD Series with Command Core™

## H.264 Dual Spectrum Night-Vision Positioning System



### CAMERA

Sensor	1/2.8" CMOS
Scanning	Progressive
Resolution	1,920 x 1,080
Digital Formats	640 x 360 @ 3x dig. zoom YUV 4:2:2 SMPTE 274M, BT.709, BT.1120, 1080p, 1080i, 720p
Frame Rate	30 fps
Camera Format	Day/Night (IR Cut Filter)
Day/Night Modes	Auto, Color, B/W
S/N Ratio	>50 db

### SENSITIVITY

Standard	(f1.4, 1/30, 30 IRE)
Color	0.25 lux (0.025 fc)
B/W	0.024 lux (0.0024 fc)
Digital Slow Shutter	(f1.4, 1/2, 30 IRE)
Color	0.015 lux (0.0015 fc)
B/W	0.0015 lux (0.00015 fc)

### OPTICS

Zoom Lens	30x, 4.4 to 132mm effective 264mm with 2x digital zoom
Aperture	f1.4 -> f4.6
HAFoV	63.4° to 2.1° @ 1920x1080 63.4° to 0.7° @ 640 x 360
Focus	Auto/Manual [Near, Far]
Focus Search	Normal, Bright, Point Source
Focus Sensitivity	Low, Normal, High
Iris	Auto/Manual [Open/Close]
Lens Speed	Three [Slow, Medium, Fast]
Digital Zoom	12x, Off/On [Depth]

### VISIBLE IMAGE PROCESSING

Defog Mode	Off/Auto/Manual [3 Levels, Strength and Color Adj.]
Image Stabilization	Off/On
Enhanced Intensity	Off, Enhanced, Whiteout Reduction
Dynamic Range	>90dB Off/On [3 Levels, Normal, Combo, Contrast ]
Back Light Comp	Off/On [ Level Setting ]
Shutter (AES)	Auto/Manual [1/2 -> 1/30,000]
Slow Shutter	Off/On [1/15->1/2] with Limit Setting
White Balance	Auto/Manual [Red/Blue Adjustment]
(WB) Modes	Normal, Mercury, Sodium Vapor
AGC	1 to 48db, Adjustable
Sharpness	Soft, Normal, Sharp, Sharpest
Noise Reduction	Normal, Medium, Strong, Fixed

### THERMAL CAMERA

Detector	VOx Uncooled Microbolometer
Image Resolution	640 x480
Pixel Size	17µm

Spectral Band	8 - 12 µm
Sensitivity (NEΔT)	<50 mK @ F1.0
Frame Rate	30Hz or 9Hz

### THERMAL IMAGE PROCESSING

Digital Zoom	Up to 12x
Image	Polarity, NUC, Image flip, Atuo/Manual gain [Level]
Palettes	Color and B/W selections

### THERMAL OPTICS

#### 6x Zoom

Focal Range	25-150mm, 6x, F1.6
HAFoV	25.2° to 4.2°
Lens Type	Athermalized, Hard Carbon
Focus Type	On-Demand Auto Focus, Manual [Near/Far]

#### 4x Zoom

Focal Range	26-105mm, 4x, F1.6
HAFoV	23.6° to 5.9°
Lens Type	Athermalized, Hard Carbon
Focus Type	On-Demand Auto Focus, Manual [Near/Far]

#### Dual FoV

Focal Range	45/135mm Dual Fov, F1.6
HAFoV	14.3°/4.6°
Lens Type	Athermalized, Hard Carbon
Focus Type	One-Shot Auto Focus, Manual [Near/Far]

#### Fixed FoV

Focal Range	25mm, 50mm or 100mm F1.6
HAFoV	17.6° [25mm] 12.4° [50mm] 6.2° [100mm]
Lens Type	Athermalized, Hard Carbon
Focus Type	Fixed

### IP STREAM

Video Streams	5 or more video streams dependent on available processing budget
Video Codec	H.264 Base, Main and High Profiles, MJPEG
Video Protocols	RTSP/RTP RTSP/RTP Interleave HTTP Tunneling RTP Multicast
Video Resolution	1080p, 720p, D1 [Visible] D1, VGA, CIF [Thermal]
Video Frame Rate	1 to 30 fps, 30 fps default
Video Data Rate	256Kbs to 8Mbs
Video Rate Cntrl	Variable or Constant
Video GOV	1 to 600, 30 default
Video Latency	Four frames (0.133 sec.)
Video Trans.	99.999% error free

### ANALOG INTERFACE

Video Format	NTSC or PAL
Serial PTZ	RS422, full/half duplex,

Protocols	1,200 to 115k baud adjustment, data, stop and parity bit configuration. CohuHD Legacy, Pelco D, Ultrak, NTCIP 1205, A/D, FAST, Javelin
-----------	-------------------------------------------------------------------------------------------------------------------------------------------------------

### NETWORK INTERFACE

Network Format	802.3u 100Base-T, MDI-X auto-sensing, full duplex
Network Protocol	TCP, UDP, IPv4, ICMP, DNS, IGMPv2/v3, DHCP, RTP, RTSP, RTCP, NTP, HTTP, SOAP, HTTPS ARP, FTP, SMTP, SNMP/NTCIP, Telnet. ONVIF Profile S
Media Players	VLC, Quick Time or any media player compliant with RFC 2326, 3984, 3550, 2435, ISO/IEC 13818-1
ONVIF	Profile S
Camera Protocols	ONVIF, NTCIP 1205, CohuT, CohuHD legacy
Security	4 Levels: Admin, Operator, User, Anonymous [User Name + Password], Digest Authentication
Updates	File upload over network using camera web server interface
Configurations	Stored in Non-Volatile Memory
Browsers	IE11, Firefox, Chrome

### DIGITAL I/O INTERFACE

Digital Circuits	Four digital I/O circuits, user defined as either input or output
------------------	-------------------------------------------------------------------------

### COMMAND CORE ACTION ENGINE

Input Triggers	Digital input, FTP error, Valid or invalid login, Tour stopped, Timer, Scheduler, Preset reached, PTZ moved, Maintenance, User command
Output Actions	Digital output, Activate wiper, FTP image, Send Email, Send Text, Start Preset or Tour, Display OSD message, Timer/ Scheduler On/Off mode control, Delay, Reset system
Trigger Queuing	User selectable mode. Processes output actions by trigger priority, first in, or last in.
Servers	Multiple FTP and EMAIL servers can be configured for use by camera system

# RISE 4290HD Series with Command Core™

## H.264 Dual Spectrum Night-Vision Positioning System



### ON SCREEN DISPLAY (OSD)

OSD Capacity	Up to 7 OSD Elements can be selected for display on video
OSD Elements	Text, Preset, Position, Compass, Date/Time, Sector, Maintenance, Action Event
OSD Characters	Up to 40 characters per text element
OSD Size Adjustable	from 12, 18, 24, 30, 36, 42, 48, 54, 60, 72, 84 or 96 pt. size
OSD Color	White, Black, Green, Red, Blue
OSD Transparency	Adjustable from 0-100%
OSD Background	Transparent, Black
OSD Location	Upper Right/Left, Lower Right/Left, Center, Custom
Banner Display	On/Off, Top/Bottom, 4 OSD elements
Logo Display	BMP, JPEG, GIF Format, [x,y] position, Transparency

### PRIVACY MASKS

#### VISIBLE CAMERA ONLY

Capacity	Up to 8 Rectangular Masks.
Color	Red, orange, green, blue, purple, grey
Blur	Solid, fine, medium or coarse pixelated
Opacity	25, 50 or 75%
Brightness	4 levels of adjustment

### POSITIONING DRIVE

Pan Range	360° continuous rotation
Tilt Range	360°
Preset Speed	Peak speed of 120°/sec 180° movement < 3 seconds
Manual Speed	0.1° to 45°/second
Speed Resolution	> 64 Variable speed levels
Repeatability	+/- 0.05°
Resolution	+/- 0.05°
Presets	Up to 256, Includes pan, tilt, zoom, focus, preset ID, I/O output state
Tours	Up to 256, Includes presets with dwell, speed, direction and recurrence properties
Auto Park	Returns to a preset or tour after timer expires, Timer Value [ Off, 1 Minute to 999 Hours]
Features	Auto focus/iris on PTZ, Proportional PTZ, Video freeze on preset, High wind/vibration mode, Set north calibration,

Inverted mounting mode, Synchronized visible/thermal zoom lens FoV mode

### ELECTRICAL

Input Voltage	PoE++, 24Vdc/ac or 120Vac, model dependent
Power	30w, up to 60w with heaters ON
Voltage Range	NEMA standard TS 2-2003 section 2.2.7 tests C thru H
Transient/Surge Emissions	Certified to CISPR 24 levels
Pigtail Cable(s)	Certified to CISPR 22 levels
	Approx. 24"

### MECHANICAL

Weight	35 lbs (15.9 kg) (fixed lens)
Dimensions	Refer to next page
Shipping	44lbs (20kg)
Construction	Powder Coated aluminum
Faceplate	Visible camera, optically correct glass. Thermal camera, hard carbon coated germanium
Faceplate Wiper	Visible Camera, [On/Off, Dwell, Time Out Settings]
Sunshield	Included as standard
Inverted Mounting	Yes, Software selectable
Connectors	RJ45, AMP, MS, Model dependent
Color	Desert Tan
IK10+	Camera System except optics faceplates.

### ENVIRONMENTAL

Ingress Protection	Visible Camera - IP68, Pressurized with Dry Nitrogen, 3.5 psi. Thermal Camera - IP67
	Positioner Body - IP66
Humidity	Up to 100%
Operating Temp	NEMA TS2 para. 2.2.7 -40°F to 167°F (-40°C to 75°C), -22°F (-30°C) Cold Start
Vibration	Per NEMA TS2 para. 2.2.8. 5-30Hz sweep @ 0.5g applied in each of 3 mutually perpendicular planes.
Shock	Per NEMA TS2 para. 2.2.9. 10g applied in each of 3 mutually perpendicular planes
Wind Survivability	Up to 150 mph - 120 mph for 45 minutes - 150 mph for 15 minutes

### EMC CERTIFICATIONS

CE, FCC Part 15B, RoHS  
AS/NZS CISPR 22:2009+A1:2010  
CAN/CSA-CISPR 22-10  
EN 55022:2010+AC: 2011  
EN 55024:2010  
EN 61000-3-2:2006+A1:2009+A2:2009  
EN 61000-3-3:2013  
EN 61000-4-2: 2009  
EN 61000-4-3: 2006 +A1:2008 +A2:2010  
EN 61000-4-4: 2004  
EN 61000-4-5: 2006  
EN 61000-4-6: 2009  
EN 61000-4-8: 2010  
EN 61000-4-11: 2004  
SASO (Pending)

### ACCESSORIES

#### Mounts

Pedestal	7411542-001
Wall	8425-7
Pole	8503-0
Corner	8503-1 (discontinued)
Parapat	8503-2 (discontinued)
7.0" BC Plate	8481-9

#### CAT5e Cables

8194602-xxx [where xxx = 025, 055, 100, 150, 200, 250, 300, 328] denoting cable length in feet. Includes RJ45 connectors at each end of cable.

#### Accessory Cables

CA277, CA278 Series

#### Power Supplies

7412007-003	PoE++, 60W, 110/220vac IP50, -34 to 74C
7411543-010	24Vac, 100VA, 110/220vac, IP66, -34 to 74C

### WARRANTY

Three (3) years on camera and positioner system. Lifetime warranty on camera head enclosure moisture ingress.

# RISE 4290HD Series with Command Core™

## H.264 Dual Spectrum Night-Vision Positioning System



### PIGTAIL CONFIGURATIONS (24" PIGTAILS)

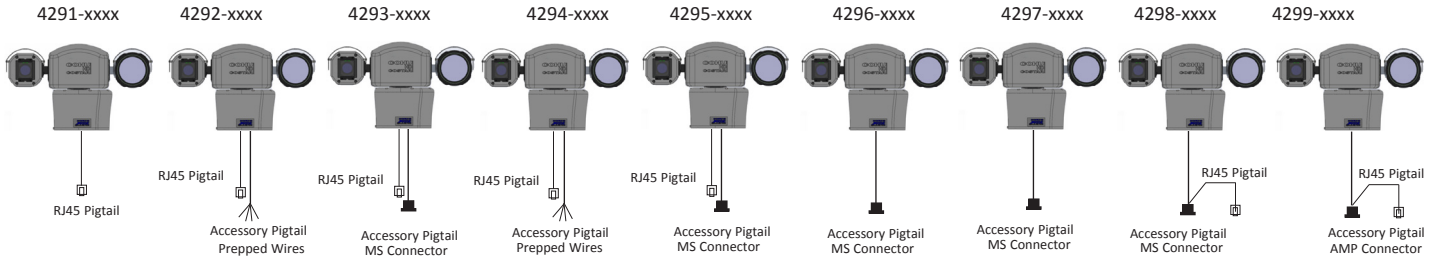

### 4291-XXXX THRU 4296-XXXX DIMENSIONS

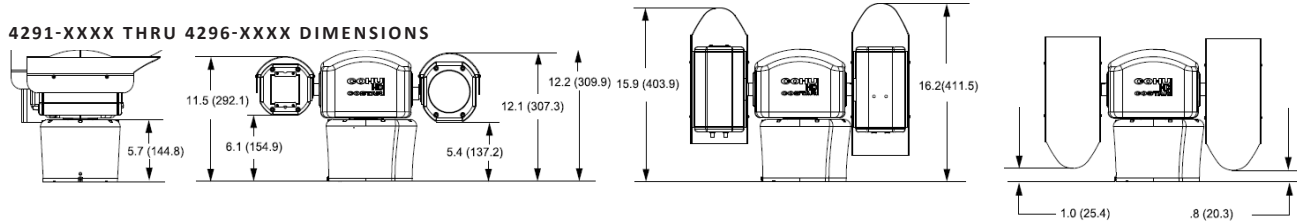

### 4297XXXX THRU 4299-XXXX DIMENSIONS

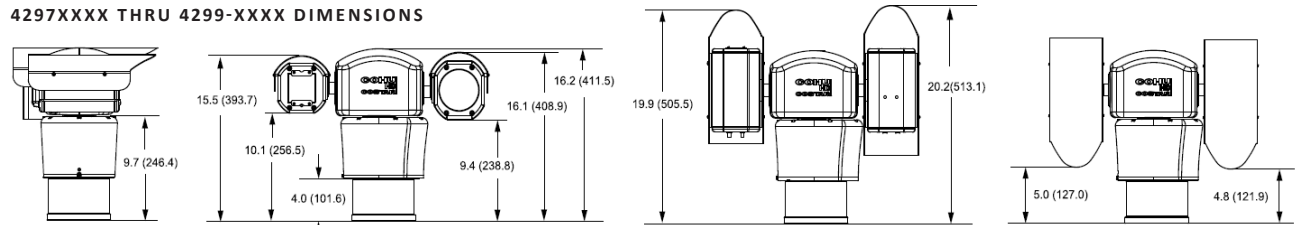

### TYPICAL CLEARANCE

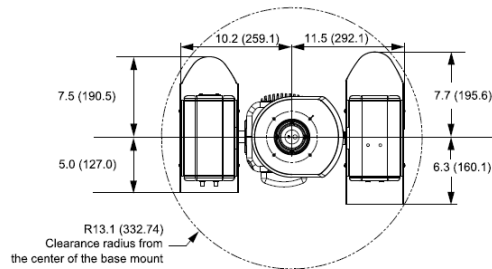

RJ45 IP67 Coupler, P/N 7610203-002  
CAT5e/6/6a shielded cable with a 6mm-7mm O.D. is required for waterproofing.

### ORDERING INFORMATION (EX. 4291-1A10-GY)

Model Structure	Option #	Option Description
Product Series	429	RISE 4290HD Series Dual Spectrum Camera Positioner
Power and Connection Options	1	PoE++ Power, RJ45 Pigtail
	2	PoE++ Power, RJ45 Pigtail, Accessory Pigtail
	3	PoE++ Power, RJ45 Pigtail, MS Conn. Accessory Pigtail
	4	24 Vac Power, RJ45 Pigtail, Accessory Pigtail, Wires
	5	24 Vac Power, RJ45 Pigtail, Accessory Pigtail, MS Conn.
	6	24 Vac Power, MS Connector Pigtail
	7	120Vac Power, MS Connector Pigtail, Helios Pinout
	8	120Vac Power, MS Connector Pigtail, RJ45 Whip, i-Series Pinout
	9	120Vac Power, AMP Connector Pigtail, RJ45 Whip, i-Series Pinout
	-	Model Number Separator
Visible Camera Options	1	HD 1080p 30x Camera Module with Wiper
Thermal Camera Options	1	640x480 30Hz LWIR, 45/135mm 3x Mag Dual Field of View Lens
	2	640x480 30Hz LWIR, 25 to 150mm Zoom Lens
	3	640x480 30Hz LWIR, 25mm Fixed Lens
	4	640x480 30Hz LWIR, 50mm Fixed Lens
	5	640x480 9Hz LWIR, 45/135mm 3x Mag Dual Field of View Lens
	6	640x480 9Hz LWIR, 25 to 150mm Zoom Lens
	7	640x480 9Hz LWIR, 25mm Fixed Lens
	8	640x480 9Hz LWIR, 50mm Fixed Lens
	9	640x480 30Hz LWIR, 100mm Fixed Lens
	A	640x480 30Hz LWIR, 26-105mm Zoom Lens
	B	640x480 9Hz LWIR, 100mm Fixed Lens
	C	640x480 9Hz LWIR, 26-105mm Zoom Lens
	-	Model Number Separator
Options	1	None
Unavailable	0	Future
	-	Model Number Separator
Color	GY	CohuHD Gray
	DS	Desert Sand

### MOUNTING EXAMPLES

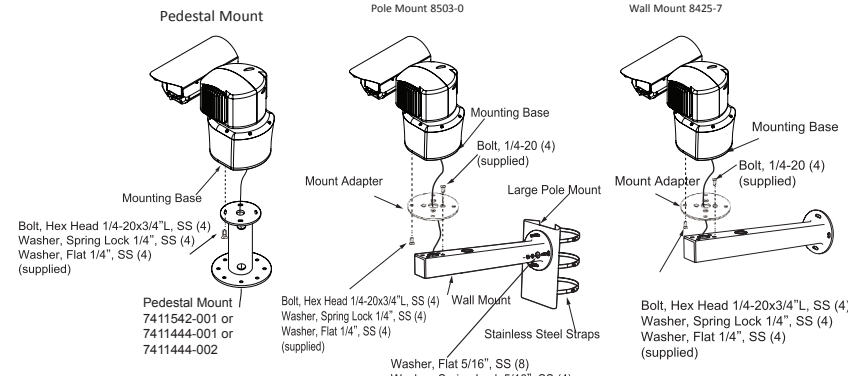

### RANGE TARGET CRITERIA

Identification = Minimum of 12 pixels through critical dimension  
 Recognition = Minimum of 6 pixels through critical dimension  
 Detection = Minimum of 2 pixels through critical dimension

Critical Dimension of Subject (square root of subjects H x W)  
 Human = 1.8m x 0.6m  
 Vehicle = 2.3m x 2.3m

Note: Ideal atmospheric and scene conditions assumed

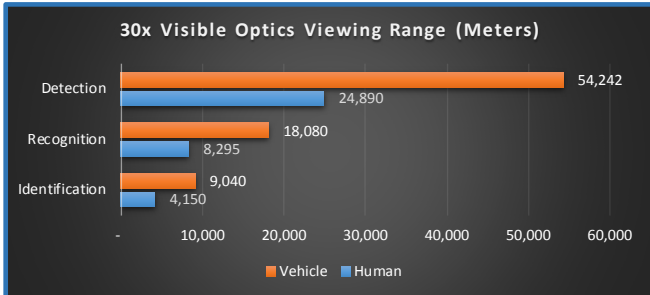
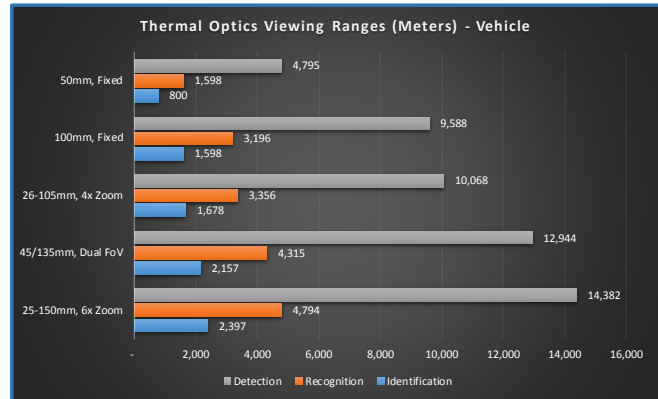
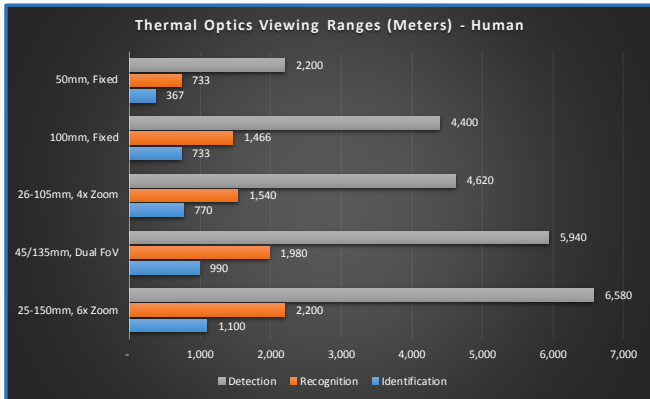

## RISE Series IP Video Cameras

### Rugged Innovation with Superior Endurance

The RISE Series IP video cameras are designed and built by CohuHD Costar for critical infrastructure applications demanding high-quality images, rugged construction and seamless interoperability. The RISE Series delivers advanced performance at unbeatable pricing.

### About CohuHD Costar™

CohuHD Costar is a leading manufacturer of high-definition video systems designed to satisfy the demanding performance requirements for critical infrastructure applications. CohuHD solutions integrate the latest high-definition video imaging and compression technologies into ruggedized camera products for monitoring in critical, sensitive environments.