

# **COHU, INC. ELECTRONICS DIVISION**

## **Installation and Operation Manual**

---



**Figure 1. Model 4816 and Model 4817 Cameras**

## **4816 and 4817 Monochrome Frame Transfer CCD Cameras**

Technical Manual 6X-1083C

June 21, 2012

---

[www.cohu-cameras.com/content/contactus](http://www.cohu-cameras.com/content/contactus)

[www.cohu-cameras.com](http://www.cohu-cameras.com)

[info@cohu.com](mailto:info@cohu.com)

---

**6X-1083C**

**COHU**

**Table 1. Specifications**

<b>ELECTRICAL</b>	
Imager	Single CCD using frame transfer method
Image Area	8.8 by 6.6 mm (2/3-inch format)
Active Picture Elements	754 (h) by 484 (v)
Cell Size	11.5 μm (h) by 13.5 μm (v)
Resolution	Horizontal: 565 lines Vertical: 350
Sensitivity, Full Video	0.20 lux at faceplate with nominal gain (agc off)
Shutter	1/60 sec
Spectral Response	See figure 3
Scanning System	RS-170A; 2:1 interlaced
Video Output	1.0 V p-p; 75 ohms, unbalanced
Gamma	0.45 or 1.0, jumper selected
Gray Scale	Renders all shades of gray on EIA tv resolution chart 1956
Gain: agc/mgc	20 dB variable gain (nominal gain = 8 dB)
Auto Lens	Jumper selectable sync insert
Signal to Noise Ratio, 25 °C	48 dB (nominal gain)
Sync	EIA RS-170(A) crystal, External H and V Drive
Power Options	12 V dc ±10% 115 V ac 60 Hz, ±10% (with optional wall transformer providing 12 V dc)
Power Consumption	<2.5 W
<b>MECHANICAL</b>	
Dimensions	See figure 5
Weight, less lens	465 grams (16.3 oz)
Type of Lens Attachment	Adjustable C-mount
<b>ENVIRONMENTAL</b>	
Ambient Temperature Limits	Operating: -10 to 50 °C (14 to 122 °F) Storage: -30 to 70 °C (-22 to 158 °F)
Altitude	Sea level to equivalent of 3048 meters (10,000 feet) [20 inches of mercury]
Humidity	Up to 95% relative humidity, non-condensing
Shock	40 g's (IEC 68)
Vibration	12 g's (IEC 68)

## 1.0 GENERAL DESCRIPTION

This section gives a brief description of electrical and mechanical characteristics of the Camera. Additional sections provide more detailed information regarding installation and operation.

Table 1 lists specifications. Figure 2 is a model number interpretation diagram for this Camera.

### 1.1 ELECTRICAL CHARACTERISTIC

This camera has a 2/3 inch frame transfer sensor with extended sensitivity response into the UV and IR regions of the spectrum (figure 3). Operation at UV wavelengths requires a specially modified version of the camera with the faceplate glass removed from the sensor.

#### 1.1.2 Functional Description

Figure 4 shows typical interconnections for a camera when it is being used with an external sync generator providing horizontal and vertical drive.

This illustration shows both a manual iris lens and an auto iris lens.

Video output from the camera connects to a tv monitor in this illustration but a frame grabber or other imaging devices could also be used.

#### 1.1.3 Sync Modes

The camera can operate in either of two sync modes:

1. Internal crystal sync or
2. External horizontal and vertical (H & V) drive.

Applying H & V drive “captures” internal sync from the camera so that it can be externally timed with other equipment.

Internal sync operates to the specifications of RS-170(A). Frame rate for this specification is 59.94 Hz.

### 1.2 MECHANICAL CHARACTERISTICS

Figure 5 shows dimensions of the camera. Figure 13 shows multiple views of the camera.

The camera has front and rear castings mounted to a bottom rail running the length of the camera.

A slide-on cover seals tightly between the front and rear castings to protect internal features of the camera. A trim plate fits over rear panel connectors to hold the cover in place. A single screw in the center of the plate (figure 6) secures it in place.

Threaded mounting holes on the bottom of the camera (figure 7) accept the industry standard 1/4-20 bolts for securing the camera to a mounting base.

A C-mount lens adapter threads into the front casting to provide for back focusing of the lens.

## 2.0 INSTALLATION

### WARNING

This Camera can be used with power supplies that operate from 115 V ac. Use all appropriate care when working with 115 V ac power.

### 2.1 EQUIPMENT SUPPLIED

Table 2 lists the items typically supplied with this camera. Items contained in the Accessory Kit are listed in table 4.

### 2.2 EQUIPMENT REQUIRED BUT NOT SUPPLIED

Table 3 list some typical items that may be required to make use of the camera. Depending on the required application, other items may also be required.

Deionized air is listed as a requirement for cleaning dust from the faceplate glass of the sensor. Canned air or air from a standard hose generate static charges that can destroy the sensor and other components.

### 2.3 Power Requirements

The camera operates from 12 V dc at less than 2.5 watts .

For 115 V ac operation, a power pack is used to supply 12 V dc to the camera.

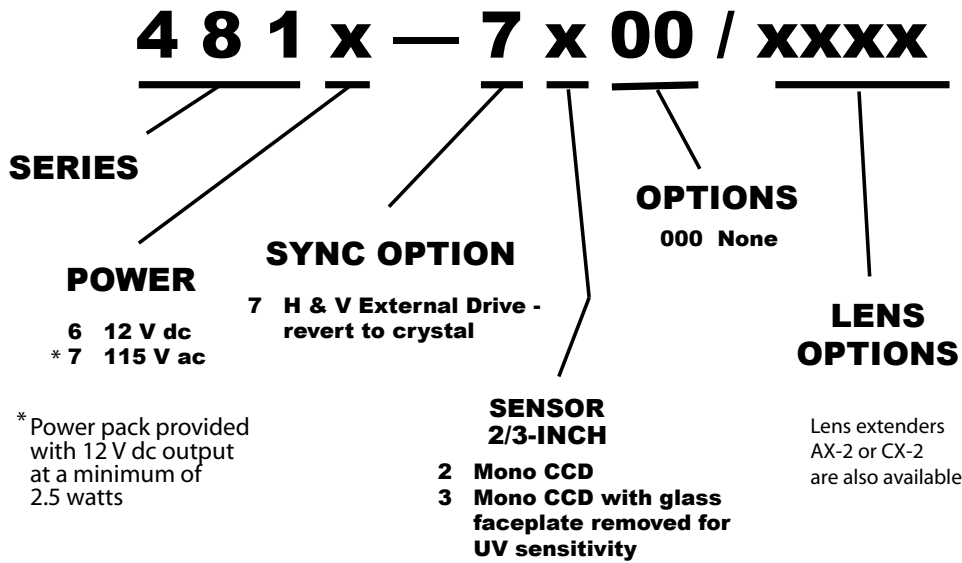

**Figure 2. Model Number Interpretation Diagram**

**2.4 CABLING REQUIREMENTS**

All cables used with this camera should be shielded so that the best possible EMC characteristics are obtained.

The Camera has four interface connectors on the rear panel: (figure 6 and table 5)

1. Video (cable required)
2. Power (cable required)
3. Lens (cable required only when an auto iris lens is used)

4. Auxiliary (cable required only when external H & V drive is to be applied)

At a minimum, then, two cables must be connected to the camera rear panel. One to apply power and one to connect video to a tv monitor or other device.

If an auto iris lens is being used, the cable attached to the lens will plug into the camera Lens connector.

**Figure 3. Sensor Response**

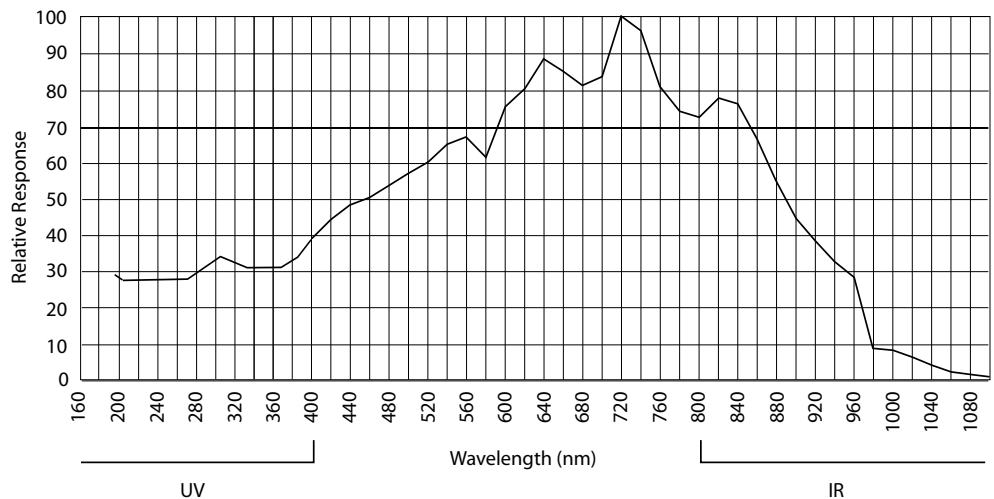

Note: Response in the UV region requires that the sensor faceplate glass has been removed at the factory.

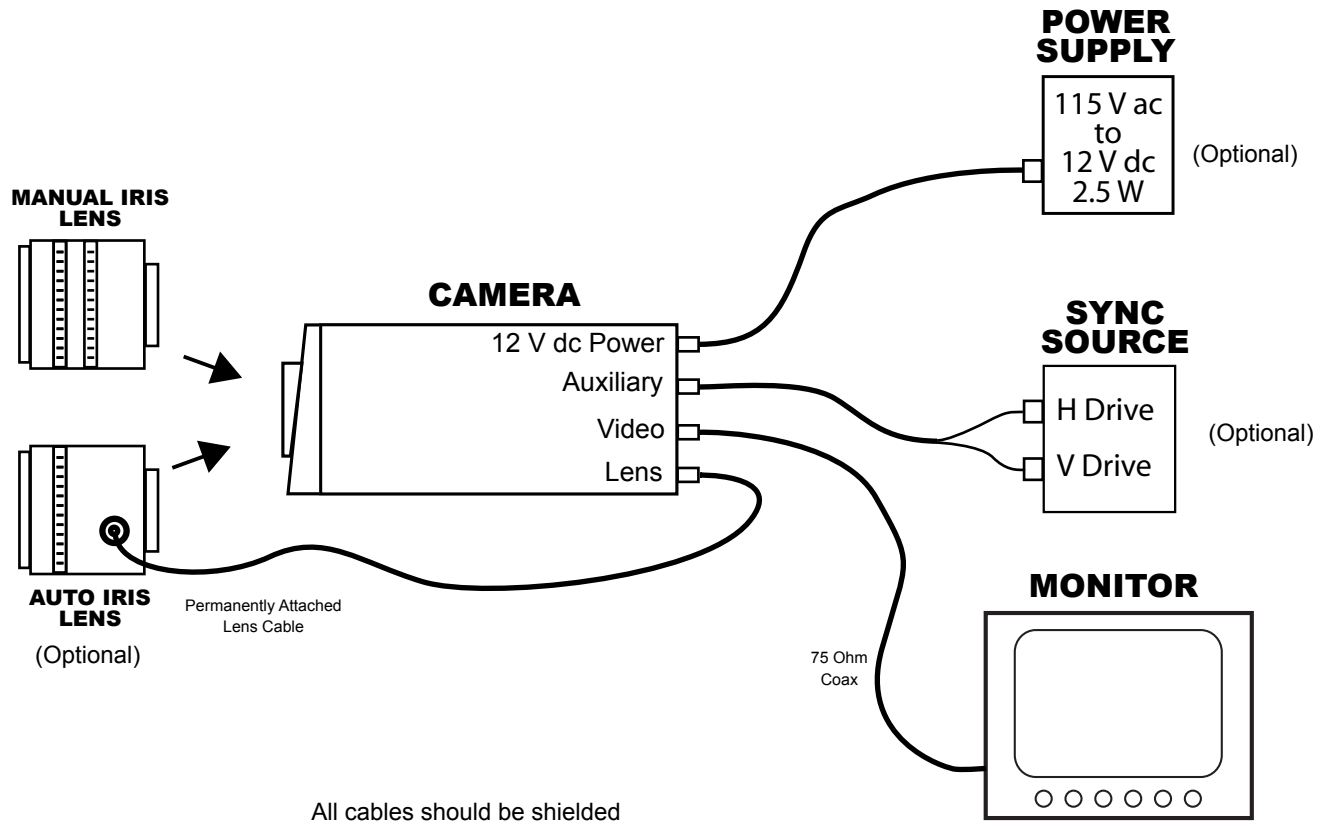

**Figure 4. Typical Interconnection Diagram**

If external horizontal and vertical drive are to be applied to the camera for control of sync functions, a cable will be required for the AUX connector (figure 9) on the rear of the camera.

Cable plugs listed in this manual are supplied with backshells. The accessory kit provides an additional Switchcraft backshell in the event that a larger diameter cable is used for either the power cable or the lens iris cable.

**2.5 INSTALLATION PROCEDURE**

The following paragraphs summarize a typical installation procedure. If any internal adjustments or jumpers need to be changed refer to section 2.6.

Figure 4 shows a typical installation including an optional sync generator for external horizontal and vertical drive. Figure 6 illustrates the rear panel of this camera where all cable interconnections are made.

**2.5.1 Mounting**

Mount the camera to a suitable base using one or two industry standard 1/4-20 bolts. Bolt length must be just long enough to thread into the camera base a few threads but no so long that it jams into the blind hole provided in the base of the camera.

<b>ITEM</b>	<b>DESCRIPTION</b>
1	4816 or 4817 Camera
2	Installation and Operation Manual (6X-1083)
3	C-mount adapter. Part 2010637-350
4	Setscrew, nylon tipped, 4-40 x 15/64 (installed in camera front casting for C-mount lockdown) Part 2010258-001
5	Screw, machine, black truss head, phillips 4-40 x 1/4 (installed to secure real panel bezel in place) Part 2010570-021
6	Accessory Kit 8370-2. See table 4

<b>ITEM</b>	<b>DESCRIPTION</b>
1	Power Supply, 12 V dc 2.5 W
2	Lens, manual or auto-iris
3	75 ohm Coaxial Cable (see section 2.5.3 for quality requirements)
4	Television Monitor (RS-170)
5	Sync Generator (RS-170)
6	Neutral Density Filters
7	Deionized air for maintenance

*Note. Neutral density filters are helpful when adjusting back focus. Deionized air is required for removing dust from the sensor faceplate glass.*

<b>ITEM</b>	<b>DESCRIPTION</b>	<b>COHU PART NO.</b>	<b>MFG PART NO.</b>
1	Plug, Aux, H&V Drive, 6 pin	1310349-006	Hirose SR30-10PE-6P
2	Plug, Power, 3 socket	1310356-103	Switchcraft TA3F
3	Plug, Lens, 4 Pin	1310356-104	Switchcraft TA4F
4	Strain Relief Bushing (contingent use)	1310356-401	Switchcraft P2983
4	Wrench, Allen Hex, 5/64 across flats	9710010-012	Commercial part

*Note: Item 4 is an extra strain relief for larger diameter cables. It can be used in place of one of the small diameter strain relief supplied with item 2 and item 3.*

**2.5.2 Power Connection**

Apply 12 V dc power to the camera (figure 12) using a shielded cable. Power draw is less than 2.5 watts.

**2.5.3 Video Connection**

This video connection (figure 10) should be made with a high quality copper conductor 75 ohm cable. Do not use any 75 ohm cable having iron conductors.

**2.5.4 External Drive Connection**

External horizontal and vertical drive can be applied to the camera rear panel AUX connector (figure 9) to take control of camera sync.

These inputs should be negative-going from about +4 volts to zero.

This cable should have an overall shield in addition to the shielded H and V cables inside.

**2.5.6 Lens Installation**

The lens should be fully threaded into the C-mount adapter and snugged tight. But do not over-tighten.

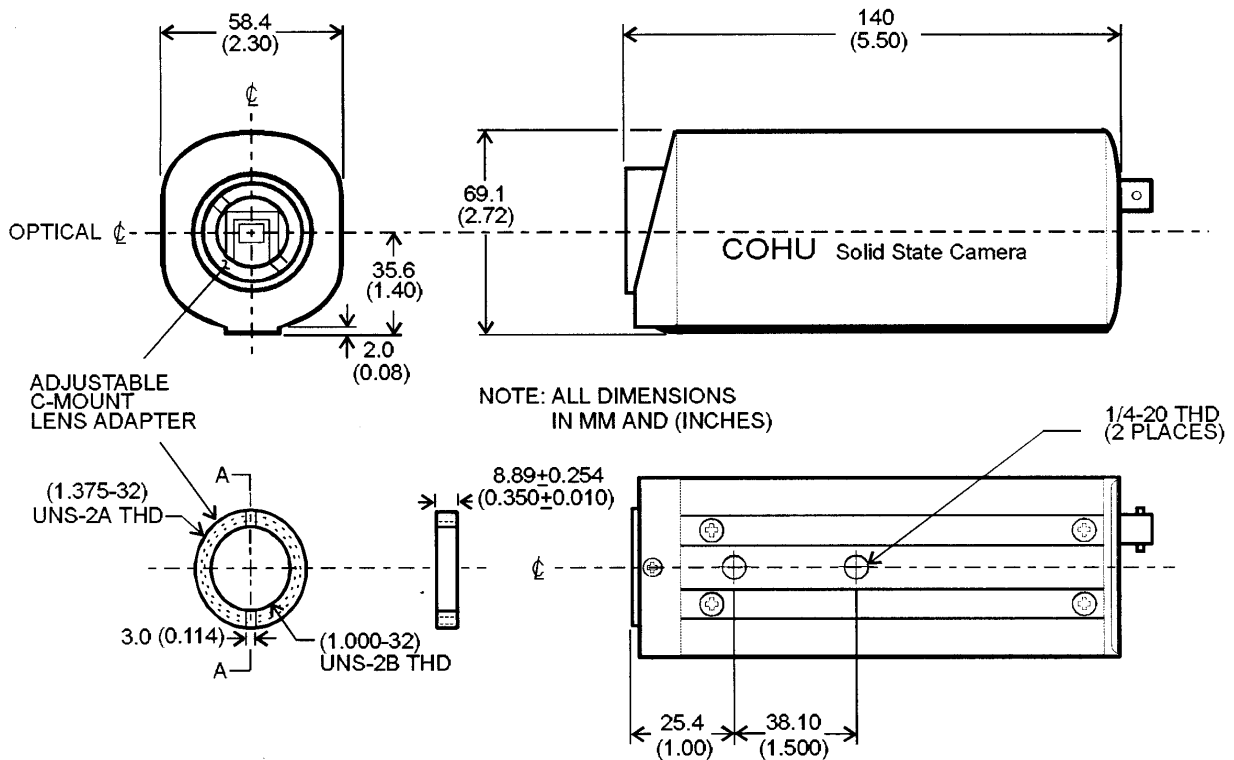

**Figure 5. Dimensions**

All adjustments for back focus are made by rotating the lens and C-mount adapter as a unit in and out of the camera.

Before attempting to make any adjustments be sure the setscrew has been loosened so that the adapter can rotate. The setscrew is nylon tipped, so do not overtighten it when securing the adapter in place after back focusing.

**2.5.6.1 C-mounts**

This camera is intended for use with C-mount lenses. C-mount lenses have a 1-inch diameter threaded connector at the back. (1.000-32 UNS-2B).

The industry specified back focus distance from the last lens element and/or shoulder of the lens is 17.526 mm. In practice, however, lenses typically focus their image somewhere near this specified distance but typically not exactly at it. This is due to manufacturing tolerances — both with the lens and with placement of the sensor within the camera housing.

The camera uses an adapter ring to properly position the lens at its required back focus distance — what ever it may be. This ring is internally threaded (1.000-32 UNS-2B) to accept the lens and externally threaded (1.375-32 UNS-2A) to thread into the camera front casting ahead of where the sensor is located.

The lens is fully threaded into this adapter ring and the ring is then adjusted into and out of the camera casting to perform the back focus adjustment.

A setscrew in the camera front casting locks this adjustable ring in place once proper back focus is obtained.

It should be mentioned that any optical filter placed between the lens and the sensor changes the back focus distance. Adding a filter requires that the lens be positioned farther away from the sensor. This is due to the different refractive indexes of air and the filter glass.

The C-mount adapter would have to be threaded out of the front Camera slightly to compensate for



**Figure 6. Rear View**

any added optical filter. This ability to compensate for filters is an advantage to using a C-mount adapter. By either adjusting the adapter out slightly or if necessary by using a slightly thicker adapter, it is possible to compensate for the addition of any optical filter.

The C-mount adapter provided with the camera does not have any filter glass installed. It is a straight through adapter.

**2.5.6.2 Lens Cable Connection**

If an auto iris lens is to be used with the Camera its cable will have to be plugged into the LENS connector (figure 11) on the rear Camera of the camera.

When back focusing the lens this cable may have to be unplugged so that the lens and C-mount adapter ring can be rotated.

When performing back focus, the lens should be wide open (dim scene lighting) so that the best possible focus adjustment is obtained.

If the lens is stopped down (iris nearly closed) due to bright scene lighting it is difficult to determine the best focus point.

If neutral density (ND) filters are available, they can be placed in front of the lens to reduce scene lighting entering the lens until the iris is fully open.

**2.5.6.3 Back Focus Adjustments**

This procedure assumes that backfocus is completely out of adjustment. Thus an initial adjustment is performed first. Adjust back focus as follows:

1. Be sure the viewing monitor is well focused
2. Unplug the lens cable from the back of the Camera if it has already been plugged in
3. Obtain a scene on the monitor with some sharp detail lines in it
4. Loosen the setscrew locking the C-mount adapter in place
5. Rotate the lens and C-mount adapter as a unit in and out of the camera to obtain an initial best focus.

**Table. 5. Rear Panel Interface Connectors**

ITEM	NAME	CAMERA REAR PANEL CONNECTOR		MATING CONNECTOR FOR CABLE	
		Cohu P.N	Mfg. P.N	Cohu P.N	Mfg. P.N
1	Video	1310242-011	BNC Jack	1310212-001	BNC Plug
2	Aux	1310348-006	Hirose SR30-10R-6S	1310349-006	Hirose SR30-10PE-6P
3	Power	1310356-003	Switchcraft TB3M	1310356-103	Switchcraft TA3F
4	Lens	1310356-004	Switchcraft TB4M	1310356-104	Switchcraft TA4F

*Note: An additional back shell is provided for use with items 3 or 4 (power and lens). This backshell accommodates a larger diameter cable. Backshells thread on and off the main body of the plug..*





**Figure 7. Bottom View**

6. Plug in the lens cable
7. Reduce scene lighting or use neutral density (ND) filters to force the lens iris fully open.
8. Re-adjust back focus again until the best possible focus point is obtained.
8. Snug down the setscrew — but do not over-tighten.
9. Continue to any other setup tasks yet to be completed.

#### **2.5.6.4 Auto Iris Lens Adjustments**

Other than jumper JB 2 for adding or removing sync (figure 8), the camera does not have any internal setting for changing the auto iris video output characteristic. If the jumper is removed from the two pins so that sync is not present in the lens video, reinstall it onto one pin for storage.

Figure 11 shows the rear panel connector to which the auto iris lens cable should be plugged.

Auto iris lenses typically have a gain adjustment and a peak/average adjustment. These lens controls can be used to match the lens to the camera characteristics.

## **2.6 Installation Adjustments**

This camera has four adjustment potentiometers and three repositionable jumpers. Table 6 lists their functions and figure 8 shows their locations. Note that the Vsub potentiometer is on the sensor board located behind the main board. A corner notch on the outer board provides access to Vsub.

Listing these adjustments in the manual does not imply that they should be changed from factory settings. Proper adjustment of the camera to factory specifications requires step-by-step procedures, test equipment, and knowledge of video cameras.

In particular, the Vsub adjustment on the sensor board should not require readjustment.

Setup level is easy to establish using a waveform monitor or oscilloscope. The normal setting is 7.5 IRE units above blanking.

If it is desired to operate with a lower noise level in the camera the gain potentiometer can be adjusted but at the expense of sensitivity to light.

Typical auto iris lenses operate best with sync in their video, but if it is desired to operate a lens without sync added jumper JB2 can be removed.

Cameras are typically shipped with the agc/manual gain jumper (JB3) in agc position. To operate at a manual gain setting reposition the jumper to MAN.

Likewise, if linear gamma is preferred, reposition JB1 from the factory jumper position of GAM (0.45) to the linear (LIN) side for a gamma of 1.0.

### **2.6.1 Accessing Camera Interior**

Before accessing the interior of a camera it is important to ensure that a static discharging workbench is available. This should include a grounded antistatic mat on the surface of the workbench and use of a static grounded wrist strap.

These are the minimum procedures to be taken when working inside this camera or any other types

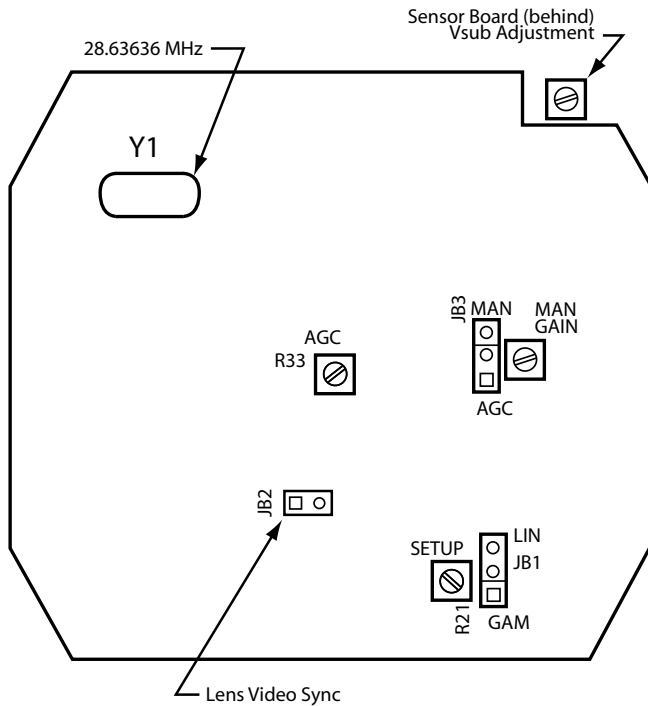

**Figure 8. Adjustment Locations**

of electronic equipment. Anyone working on electronic equipment should be completely trained in all the various antistatic measures required to prevent damage to equipment.

Working on equipment when relative humidity is below 30 percent is of particular concern

Accessing the interior of the housing requires removal of the rear panel trim plate so that the cover can slide off the chassis.

1. Refer to figure 6 and note the cross slotted screw in the center of the rear panel plate. Remove this screw and lift off the plate.
2. Place the camera rear panel connectors downward on a soft padded cloth or other material and then grasp the removable cover and slide downward — being careful not to lose

**Table 6. Adjustment Functions**

ITEM	NAME	FUNCTION
1	JB1 LIN/GAM (1.0 / 0.45)	Selects either a linear video response (LIN) or a nonlinear video response (GAM / gamma). This choice relates to the relative black/white response in the video output. Selecting GAM enhances darker areas of the scene at the expense of white areas (whites are compressed somewhat). Setting the jumper to LIN (linear) corresponds to a gamma of 1. Setting the jumper to GAM (gamma) corresponds to a gamma of 0.45.
2	JB2 (lens video sync)	When installed this jumper adds sync to the lens video output
3	JB3 MAN/AGC ON	This jumper selects either manual (MAN) gain control or automatic gain control (AGC). See items 5 and 6 below.
4	R21 SETUP	Adjusts black level reference (pedestal) above blanking. Typical setting is 7.5 IRE units.
5	R24 MAN GAIN	Establishes gain in a 0 to 20 dB range when the MAN/AGC jumper is set to the MAN position
6	R33 AGC	Establishes gain in a 0 to 20 dB range when the MAN/AGC jumper is set to the AGC position
7	R56 Vsub (sensor board)	Used to set substrate voltage (Vsub) of sensor to +5V dc +0.25/-0.0

Table 7. Auxiliary Connector Pin Functions		
Pin	NAME	FUNCTION
1	Vertical Trigger	The input for vertical trigger pulses when the camera is being synchronized to externally applied horizontal (pin 2) and vertical pulses. Negative-going +4 volts to zero
2	Horizontal Trigger	The input for horizontal trigger pulses when the camera is being synchronized to externally applied horizontal and vertical (pin1) pulses. Negative-going +4 volts to zero
3	—	No Connection
4	Ground	A grounded pin for horizontal and vertical sync signal returns
5	—	No Connection
6	—	No Connection
7	—	No Connection

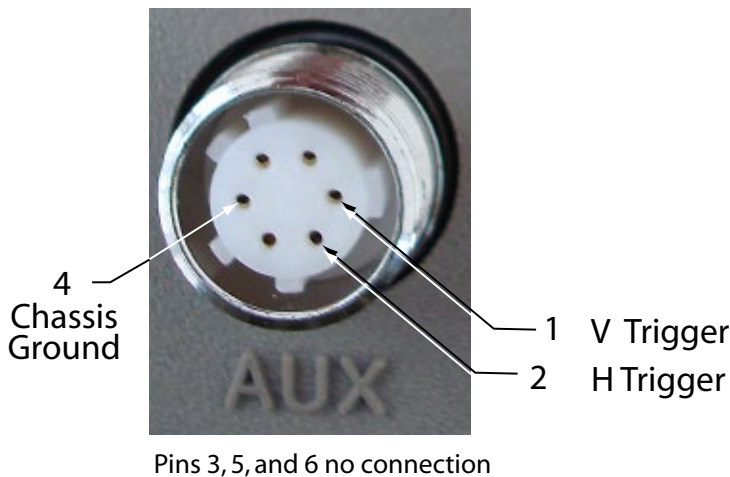

**Figure 9. Auxiliary Connector Functions**

control of the camera as the cover suddenly slides free of the chassis.

3. Slide the cover the rest of the way off the camera and set aside.
4. Proceed with any required maintenance procedures inside the camera.

### 2.7 Camera Mounting

The camera should be mounted to a secure base using one or two 1/4-20 bolts.

These bolts must not bottom out or punch through the threaded holes on the base of the camera (figure 7).

### 3.0 OPERATION

Once set up for the intended function this camera has no operation features requiring attention beyond lens settings for changing conditions.

### 4.0 MAINTENANCE

This camera is designed to operate for long periods of time without any maintenance being required.

Do not use canned air or standard hose air on the camera. Only deionized air should be used.

#### 4.1 PERIODIC MAINTENANCE

The camera does not require any periodic maintenance.

**Table 8. Auto Iris Lens Connector Pin Functions**

Pin	NAME	FUNCTION
1	Lens Video	Video output for auto iris lens. With sync is standard but internally jumper selectable.
2	Ground	Chassis ground / power return
3	+12 V dc	Power output for auto iris lens
4	Ground	Lens video signal return / ground

**4.2 PREVENTIVE MAINTENANCE**

In a normal operating environment the camera should not require any preventive maintenance.

The lens opening should always be capped with a dust cover any time the lens is removed.

Gentle puffs of air from a source of deionized air may be used in an attempt to remove any dust that has collected.

Cleaning the sensor faceplate glass should only be done with a cotton tipped swab lightly coated with lens cleaner solution. Do not flood the faceplate glass with solution.

**For modified cameras having the sensor faceplate glass removed, no object should ever touch the sensor surface.**

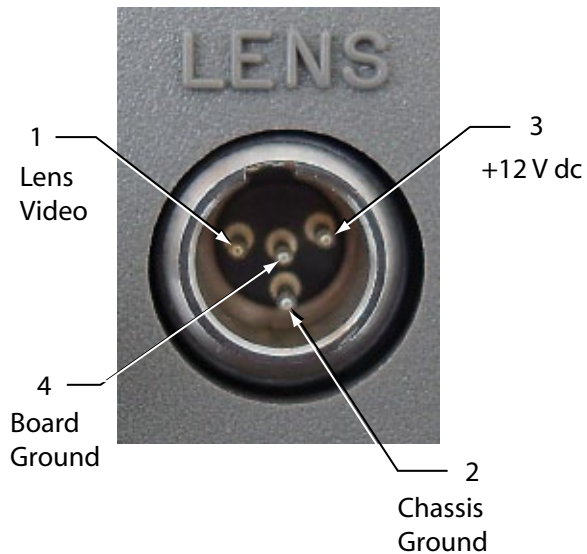

**Figure 11. Auto Iris Lens Connector Functions**

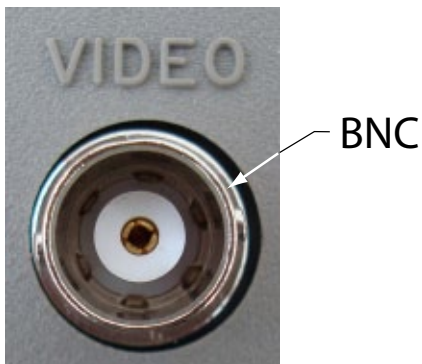

**Figure 10. Video BNC Connector**

Only gentle puffs of deionized air should be used in an attempt to remove any dust particles.

Deionized air minimized chances of static discharge destroying the sensor and other components.

Table 9. Power Connector Pin Functions		
Pin	NAME	FUNCTION
1	+12 V dc	Power Input to camera
2	Ground	Power return / Ground through power module in camera
3	—	No connection

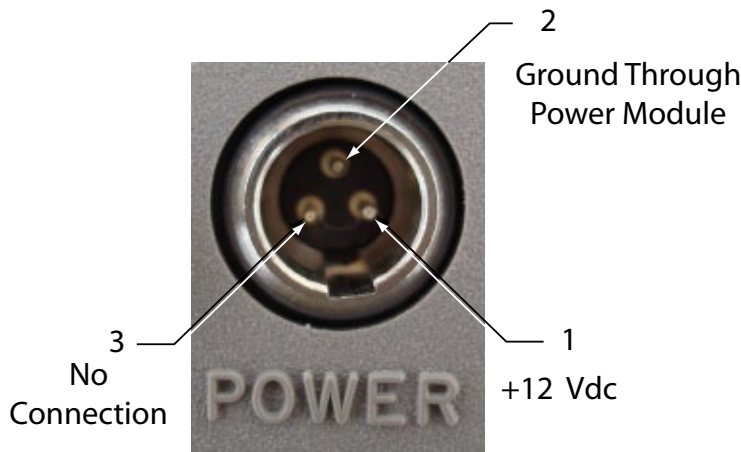

Figure 12. Power Connector Functions

## 5.0 SHIPPING AND HANDLING

This section covers both receiving inspection and shipping the Camera back to the factory if necessary.

### 5.1 UNPACKING AND RECEIVING INSPECTION

This Camera was thoroughly tested and carefully packed in the factory. Upon acceptance by the carrier, they assume responsibility for its safe arrival.

Should you receive this item in a damaged condition, apparent or concealed, a claim for damage must be made to the carrier. To return a Camera or related product to the factory for service, please contact the Customer Service Department for a Return Authorization Number.

If a visual inspection shows damage upon receipt of this shipment, it must be noted on the freight bill

or express receipt and the notation signed by the carrier's agent. Failure to do this can result in the carrier refusing to honor the claim.

When the damage is not apparent until the unit is unpacked, a claim for concealed damage must be made. Make a mail or phone request to the carrier for inspection immediately upon discovery of the concealed damage. Keep all cartons and packing materials. Since shipping damage is the carrier's responsibility, the carrier will furnish you with an inspection report and the necessary forms for filing the concealed-damage claim

### 5.2 PREPARATION FOR SHIPMENT AND STORAGE

For storage periods exceeding about one month, seal the unit in a vapor-proof bag containing a fresh desiccant pack.

Maintain the Camera in a storage environment



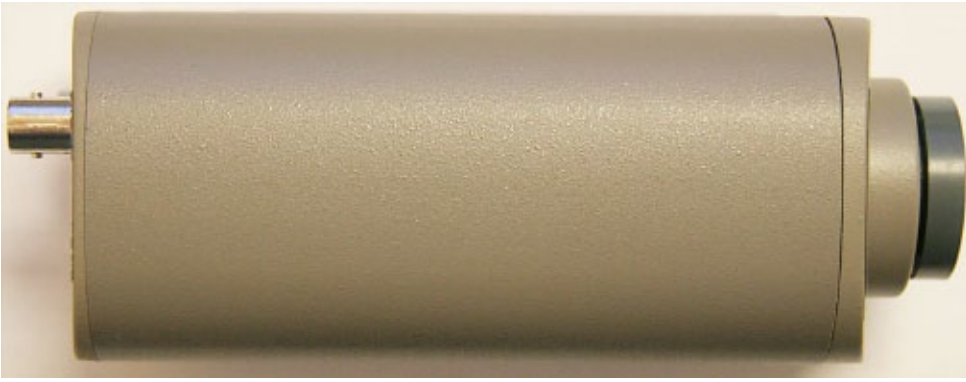

**Top**



**Right Side**



**Front**



**Left Side**

**Camera Shown with  
Sensor Dust Cover  
Installed**

**Figure 13. Model 4816 and 4817 Camera Views**

within a range of -30 to 70 °C (-22 to 158 °F).

For shipment, package with enough foam padding or other packing material to prevent damage that can occur during shipping. The original shipping carton is a good container if it has not been damaged or subjected to excessive moisture.

Please contact the Customer Service Department for a Return Authorization (RA) number before sending any shipments to the factory.

Prominently display the RA number on the outside of the shipping container(s) and on paperwork contained inside. Give a brief description of why the equipment is being returned and list the symptoms of any problems being experienced with the equipment.

**6.0 STATIC DISCHARGE PROTECTION**

Do not use canned air or standard hose air on the camera. Only deionized air should be used.

If the case is removed from the camera the following precautions should be observed.

**CAUTION**

This Camera contains sensitive devices that can be damaged by static discharge. Use appropriate static control methods when working inside the Camera.

Components used in modern electronic equipment, especially solid state devices, are susceptible to damage from static discharge. The relative susceptibility to damage for semiconductors varies from low with TTL to high with CMOS. Most other semiconductors fall between TTL and CMOS in susceptibility to static discharge. As a minimum, therefore, observe the following practices when working inside this or any other electronic equipment:

1. Use conductive sheet stock on the work bench surface.
2. Connect the sheet stock to an earth ground

3. Use a wrist strap connected to ground through an 1 megohm or greater value resistor when working at the bench.
4. Maintain relative humidity of the room above 30 percent. This may require a room humidifier. Working on circuits with relative humidity below 30 percent requires extraordinary procedures not listed here.
5. Use antistatic bags to store and transport an exposes chassis, circuit boards, and components. Use new antistatic bags. Old, used bags lose their static protection properties.

This list serves as a reminder of the minimum acceptable practices. Be sure that all static discharge devices at the work bench are properly installed and maintained. Standard grounding mats and wrist straps purchased for use at work benches are supplied with leads having current limiting resistors for safety. Never substitute with a grounding lead not having the resistor.

**WARRANTY**

Please refer to the Cohu website for product warranty information: <http://www.cohu-cameras.com/warranty/WarrantyStatement.pdf>.

Revision History		
Revision	Date	Comments
Rev B	04/29/2011	This manual has been revised to comply with the latest engineering requirements. See ECO 030972 for the list of changes
Rec C	6/21/12	<ul style="list-style-type: none"> <li>• the manual is revised to replace contact information with a link to the web page.</li> </ul>